

# 東莞永力電業有限公司

YUNG LI CO., LTD

Da Pu Industrial Zone, Gang Zi, Changping Town,  
Dong Guan City, Guangdong 523571 China.P.R.C

TEL:0769-83396797~8

FAX:0769-83396796

E-mail: sales@yung-li.com

Description: YP-48/YC-12

Customer: www.mag.de

Parts No. : CB-N-ISR

Draw No. :

## *REVISION RECORD*

1		
2		
3		
4		
5		

YUNG LI		CUSTOMER	APPROVED
CHECKED	PREPARED BY		



N/14877

1830±50

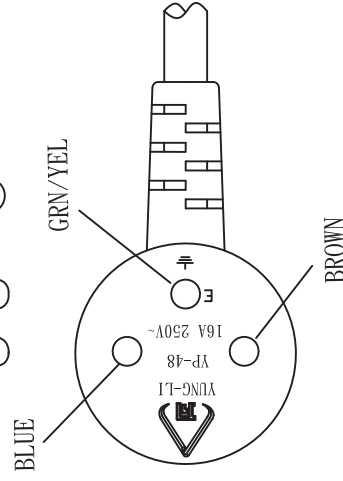
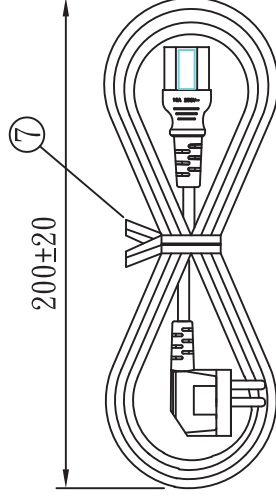
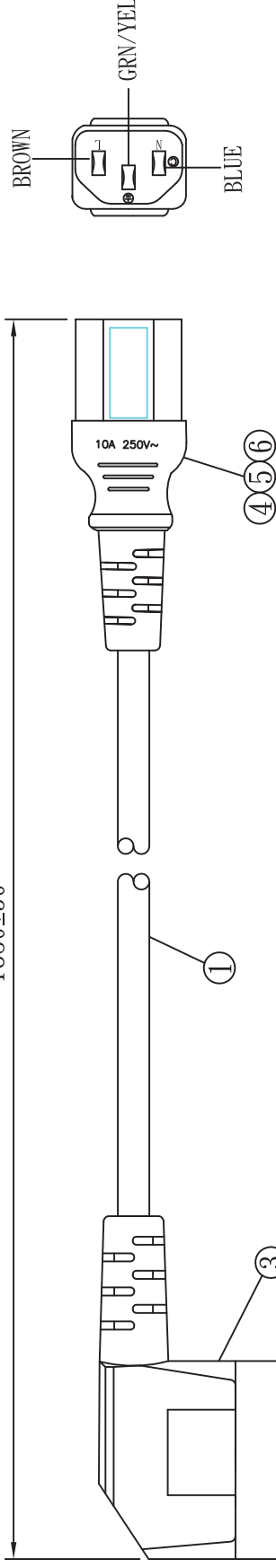

NO.	SPECIFICATION	Q'TY	REMARK
1	H05VV-F 0.75/3G BLACK	1PC	
2	BLACK FRAME	1PC	
3	YP-48 PVC PLASTIC:50P BLACK	27g/PC	
4	TER:97740	3PCS	
5	YC-12 INNER BODY	1PC	
6	YC-12 PVC PLASTIC:50P BLACK	18g/PC	
7	MINI TIE:L=130mm BLACK	1PC	

APPROVED		DATE	YUNG LI CO., LTD	
CHECKED		DATE		
DRAWN		DATE	CUSTOMER	
TYPE		YP-48/YC-12		P/N
DRAWING NO.		CY-10007	REV	B
TOLERANCE				
>0±0.30				
>1.0±0.50				
>10.0±1.0				
>20.0±2.0				
Angle: ±1°				
MATERIAL		P.V.C	UNIT	mm
SCALE				

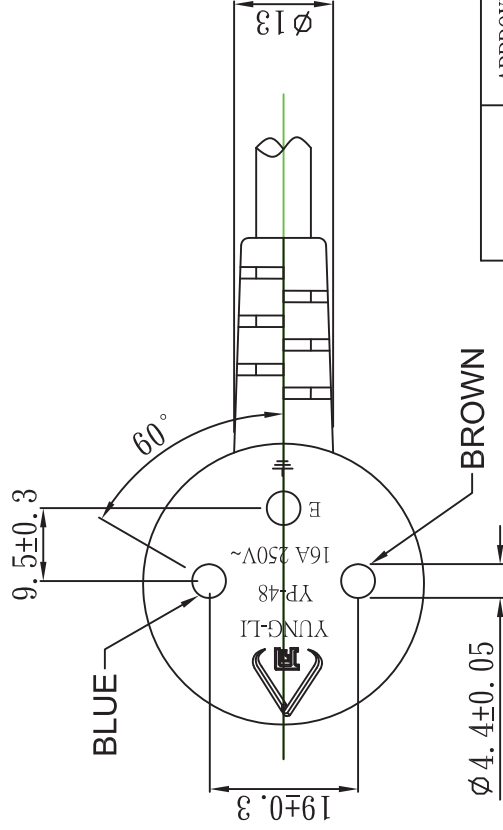
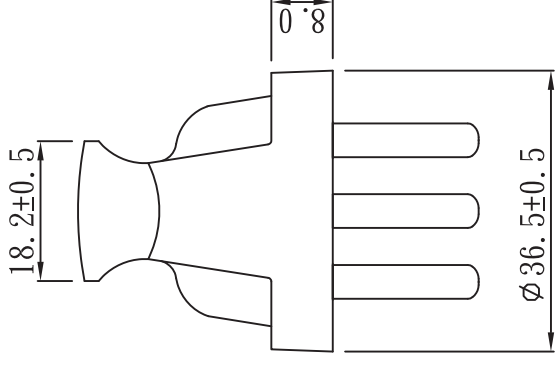
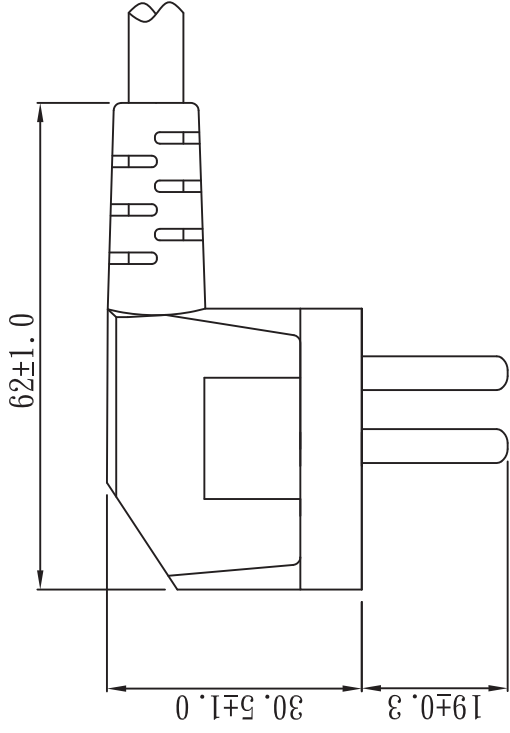

APPROVED		DATE	YUNG LI CO., LTD		
CHECKED		DATE	P/N		
DRAWN		DATE	MATERIAL	P. V. C	UNIT
TYPE		YP-48	SCALE	1:1	mm
DRAWING NO.		CY-P48V	REV	B	
TOLERANCE		>0±0.30			
		>1.0±0.50			
		>10.0±1.0			
		>20.0±2.0			
Angle:		±1°			

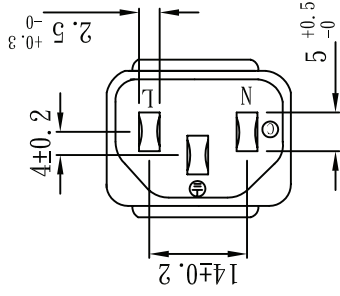
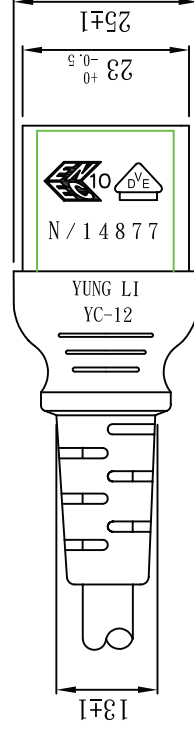
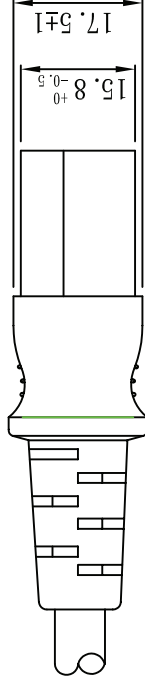
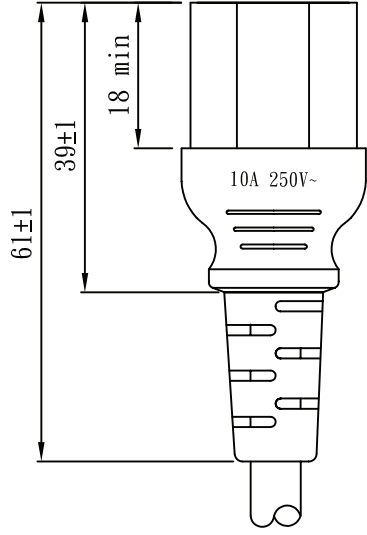

APPROVED		DATE												
CHECKED		DATE												
DRAWN		DATE												
TYPE		YC-12 (VDE)			P/N		CUSTOMER		YUNG LI CO., LTD					
DRAWING NO.		CY-C12V10A250VB			REV		B		SCALE		1:1		UNIT	
					MATERIAL		P.V.C		SCALE		1:1		UNIT	
					Angle:		±1°		SCALE		1:1		UNIT	
					TOLERANCE				SCALE		1:1		UNIT	
					>0±0.30				SCALE		1:1		UNIT	
					>1.0±0.50				SCALE		1:1		UNIT	
					>10.0±1.0				SCALE		1:1		UNIT	
					>20.0±2.0				SCALE		1:1		UNIT	
					Angle:		±1°		SCALE		1:1		UNIT	

# YUNG LI CO., LTD











## SPECIFICATION

Yung Li	Style	PVC FLEXIBLE CORDS	Document No
2012.7.18			YL-V01001
Edition	Size	<b>H05VV-F 3G 0.75mm<sup>2</sup></b>	Page
A			1/2

1. Standard: IEC 227 IEC228  
 2. Construction & Dimension

	Item	Specification
Conductor	Size	3G 0.75mm <sup>2</sup>
	Material	Annealed Bare Copper
	Construction	24/ § 0.2±0.01
Insulation	Material	PVC
	Minimum Average Thickness	0.60mm
	Minimum Thickness at any point	0.44mm
	Diameter	2.35 ± 0.10
	Identification	Blue,Brown, Yellow/Green
Core Assembly	Core Twist	3-Core
	Filler	NA
	Assembly Pair	NA
Taping	Mylar Foil	NA
Shielded	A1-Mylar Foil	NA
Drain	Material	NA
	Construction	NA
Jacket	Material	PVC
	Minimum Average Thickness	0.8mm
	Minimum Thickness at any point	0.58mm
	Overall Diameter(Approx)	6.7 ± 0.15
	Color	Any Color

### Marking:

Yung Li Co., Ltd. H05VV-F 3G 0.75mm<sup>2</sup> <VDE> NF-USE 1347  KEMA-KEUR    
     IEMMEQU Q04083  A004049 60227 IEC 53(RVV) 300/500V  SU01027-4002

# YUNG LI CO., LTD

## SPECIFICATION

Yung Li	Style	PVC FLEXIBLE CORDS	Document No
2012.7.18			YL-V01001
Edition	Size	<b>H05VV-F 3G 0.75mm<sup>2</sup></b>	Page
A			2/2

### 4. Electrical & Physical Properties

Item	Specification		
Rating Voltage	70°C 300/500V		
Conductor resistance(AT 20°C)	26.0Ω/Km MAX		
Insulation Resistance(AT 70°C)	0.011MΩ/Km Min		
Dielectric Strength	AC 2.0 KV / 15 min No Break		
Spark Test	6.0KV		
Insulation	Unaged	Tensile Strength	1.02 kgf/mm <sup>2</sup> min
		Elongation	150% Min
	Aged	Tensile Strength	80~120% (80°C x168hrs)
		Elongation	80~120% (80°C x168hrs)
	Loss of mass Test		2.0mg/cm <sup>2</sup> (max)
Jacket	Unaged	Tensile Strength	1.02 kgf/mm <sup>2</sup> min
		Elongation	150% Min
	Aged	Tensile Strength	80~120% (80°C x168hrs)
		Elongation	80~120% (80°C x168hrs)
	Loss of mass Test		2.0mg/cm <sup>2</sup> (max)
Deformation Test		70±2°C X 4hr ≤ 50%	
Cold Bend Test		-15°C x 1hr No Crack	
Heat Shock Test		150±2°C x 1hr No Crack	

### Graph:

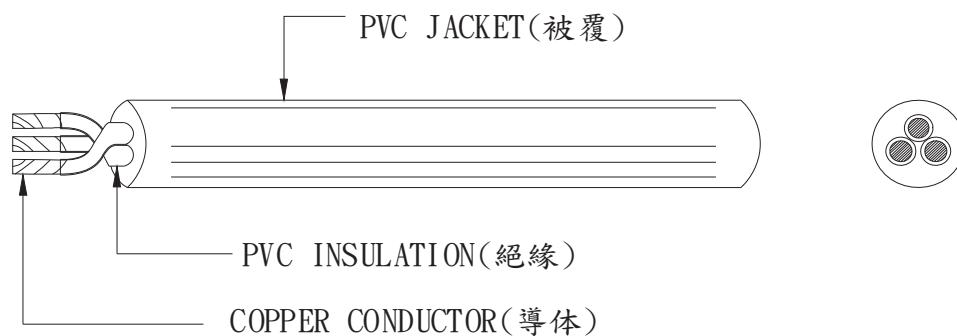

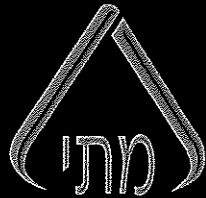

The Standards Institution of Israel

*License No. 31210  
to mark a commodity  
with the Standards Mark*

*The Standards Institution of Israel in accordance with the powers vested in it by article 11(b) of the Standards law 1953, has licensed :*

*YUNG LI CO., LTD.*

*China*

*To mark with the Standards Mark the following commodities:*

**PLUGS AND SOCKET OUTLETS FOR HOUSEHOLD AND  
SIMILAR PURPOSES NOT EXCEEDING 16 AMPERE**

TYPES: 1 . TWO POLES MOULDED PLUG YP-47 STRAIGHT 2.5A  
2 . THREE POLES MOULDED PLUG YP-48 ANGLE

*These commodities are produced in conformity with the requirements of the:*

*Israel Standard No. 32 Part 1.01*

*This license is valid until 31/12/2012*



THE STANDARDS INSTITUTION OF ISRAEL

1 / 1 / 2012

Tel Aviv

*Daniel Goldstein*

Daniel Goldstein  
Director General

## ZEICHENGENEHMIGUNG MARKS APPROVAL

Yung-Li Co. Ltd.  
Da Pu Industrial Zone, Cang Zi  
Chang Ping Town  
523571 DONG GUAN CITY  
Guangdong  
CHINA

ist berechtigt, für ihr Produkt /  
is authorized to use for their product

**Gerätesteckdose, nicht-wiederanschließbar**  
**Connector, non-rewirable**

die hier abgebildeten markenrechtlich geschützten Zeichen  
für die ab Blatt 2 aufgeführten Typen zu benutzen /  
the legally protected Marks as shown below for the types referred to on page 2 ff.



Geprüft und zertifiziert nach /  
Tested and certified according to

DIN EN 60320-1 (VDE 0625-1):2008-05; EN 60320-1:2001 + A1:2007

VDE Prüf- und Zertifizierungsinstitut GmbH  
VDE Testing and Certification Institute  
Zertifizierungsstelle / Certification

VDE Zertifikate sind nur gültig bei Veröffentlichung unter:  
VDE certificates are valid only when published on:

# VDE

Aktenzeichen: 1609800-1550-0003 / 148086

File ref.:

Ausweis-Nr. 40029577

Blatt 1

Certificate No.

Page

Weitere Bedingungen siehe Rückseite und Folgebätter /  
further conditions see overleaf and following pages

Offenbach, 2010-03-05

(letzte Änderung/updated 2011-08-16 )

<http://www.vde.com/zertifikat>

<http://www.vde.com/certificate>





Name und Sitz des Genehmigungsinhabers / Name and registered seat of the Certificate holder

Yung-Li Co. Ltd., Da Pu Industrial Zone, Cang Zi, Chang Ping Town, 523571 DONG GUAN CITY,  
Guangdong, CHINA

Aktenzeichen / File ref.

1609800-1550-0003 / 148086 / FG31 / E

letzte Änderung / updated Datum / Date

2011-08-16

2010-03-05

Dieses Blatt gilt nur in Verbindung mit Blatt 1 des Zeichengenehmigungsausweises Nr. 40029577  
*This supplement is only valid in conjunction with page 1 of the Certificate No. 40029577.*

**Gerätesteckdose, nicht-wiederanschließbar**  
**Connector, non-rewirable**

Typ(en) / Type(s):

- 1) YC-12
- 2) YC-12L

Bemessungsspannung  
Rated voltage

AC 250 V

Bemessungsstrom  
Rated current

10 A

Polzahl  
Number of poles

2-polig mit Schutzkontakt  
2-pole with earthing contact

Bauart  
Kind of construction

Normblatt C13  
standard sheet C13

Warenzeicheninhaber  
Trademark holder

Yung Li Co. Ltd.

Produktinformation  
Product information

siehe Anlage Nr. 300 + 400 + 900  
see Appendix No. 300 + 400 + 900

PAK

Das Produkt entspricht den Anforderungen gemäß PAK-Dokument  
ZEK 01.2-08.

PAH

*The product is in accordance with the requirements of  
PAH-document ZEK 01.2-08.*

Fortsetzung siehe Blatt 3 /  
continued on page 3

# VDE Prüf- und Zertifizierungsinstitut

Aktenzeichen: **1609800-1550-0003/148086**  
 File reference:

Ausweis-Nr.: **40029577**  
 Certificate No.:

Anlage Nr.: **300**  
 Appendix No.:

Seite: **1 / 1**  
 Page:

Datum: **2011-08-16**  
 Date:

Diese Anlage ist Bestandteil des Genehmigungsausweises. This appendix is part of the certificate.

**Gerätesteckdose, nicht-wiederanschließbar**  
**Connector, non-rewirable**

**2-poleig mit Schutzkontakt**  
**2-pole with earthing contact**

**zentrale Leitungseinführung**  
**straight cable entry**

**Fertigungsstätte / Place of manufacture:**

**30008928** : Kennzeichnung / Identification :

**Keine / without**

Werkstoff der Umspritzung:  
 Material of the moulding:

PVC, Type(e) CS-9731-WB; alle Farben / all colours  
 CHIA SHIN ENTERPRISES Co. Ltd.

Type without front cover:

Werkstoff der Träger Teile:  
 Material of the base:

Typ: Hersteller, Farbe  
 Type, manufacturer, colour  
 Insert:  
 PBT, Type(e) 4115(a); weiß / white  
 Chang Chun Plastics Co., Ltd.

Front cover:

Type with front cover:

Innenaussatz:  
 Insert:

Typ: Hersteller  
 Type: manufacturer  
 PBT, Type(e) 4115(a); weiß / white  
 Chang Chun Plastics Co., Ltd.



Position im VDE-Ausweis Position in VDE-licence	Typ(en) Type(s)	Leitungsdruck Marking on cable	Y-C-12	Y-C-12
<b>X</b> $\Delta$ <b>genehmigte Ausführung / approved version</b>	H05VV-F 3G 0,75 mm <sup>2</sup> (max. 2 m)		X	--
	H05VV-F 3G 1,0 mm <sup>2</sup>		X	--
	H05VV-F 3G 1,5 mm <sup>2</sup>		X	--
	H05RR-F 3G 0,75 mm <sup>2</sup> (max. 2 m)		X	--
	H05RR-F 3G 1,0 mm <sup>2</sup>		X	--
	H05RR-F 3G 1,5 mm <sup>2</sup>		X	--
	H05RN-F 3G 0,75 mm <sup>2</sup> (max. 2 m)		X	--
	H05RN-F 3G 1,0 mm <sup>2</sup>		X	--
	H03RT-H 3G 0,75 mm <sup>2</sup> (max. 2 m)		--	--
	H03RT-H 3G 1,0 mm <sup>2</sup>		--	--
	H05V2V2-F 3G 0,75 mm <sup>2</sup> (max. 2 m)		X	--
	H05V2V2-F 3G 1,0 mm <sup>2</sup>		X	--
	H05V2V2-F 3G 1,5 mm <sup>2</sup>		X	--
			--	--
			--	--

**---**  $\Delta$  **nicht genehmigt / not approved**



# VDE Prüf- und Zertifizierungsinstitut

Aktenzeichen: 1609800-1550-0003/148086  
 File reference:

Ausweis-Nr.: 40029577  
 Certificate No.:

Anlage Nr.: 400  
 Appendix No.:

Seite: 1 / 1  
 Page:  
 Datum: 2011-08-16  
 Date:

Diese Anlage ist Bestandteil des Genehmigungsausweises. This appendix is part of the certificate.

## Gerätesteckdose, nicht-wiederanschließbar Connector, non-rewirable

### 2-polig mit Schutzkontakt 2-pole with earthing contact

### abgewinkelt Leitungseinführung angled cable entry

## Fertigungsstätte / Place of manufacture:

30008928 : Kennzeichnung / Identification : Keine / without

Werkstoff der Umspritzung: Typ; Farbe  
 Material of the moulding: Type; colour  
  
 Werkstoff der Trägerenteile: Typ; Hersteller; Farbe  
 Material of the base: Type; manufacturer; colour  
  
 Inneneinsatz: Typ; Hersteller  
 Insert: Type; manufacturer

PVC, Typ(e) CS-9731-WB; alle Farben / all colours  
 CHIA SHIN ENTERPRISES Co. Ltd.

Insert:  
 PBT, Typ(e) 4115(a); weiß / white  
 Chang Chun Plastics Co., Ltd.  
  
 Front cover:  
 PBT, Typ(e) 4115(a); black / schwarz  
 Chang Chun Plastics Co., Ltd.

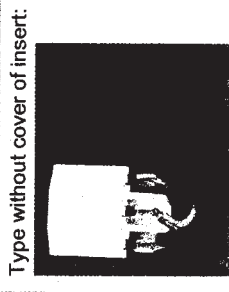

Position im VDE-Ausweis Position in VDE-licence	Typ(en) Type(s)	Leitungsaufdruck Marking on cable	YUNG LI	I-SHENG	WONDERFUL Yong Tai	X ≙ genehmigte Ausführung / approved version			--- ≙ nicht genehmigt / not approved						
						H05VV-F 3G 0,75 mm² (max. 2 m)	H05VV-F 3G 1,0 mm²	H05V-F 3G 1,5 mm²	H05RR-F 3G 0,75 mm² (max. 2 m)	H05RR-F 3G 1,0 mm²	H05RR-F 3G 1,5 mm²	H05RN-F 3G 0,75 mm² (max. 2 m)	H05RN-F 3G 1,0 mm²	H05V22-F 3G 1,0 mm²	H05V22-F 3G 1,5 mm²
2)	YC-12L					X	X	X	X	X	X				
2)	YC-12L					X	X	X	X	X	X				
2)	YC-12L					X	X	X	X	X	X				



VDE Prüf- und Zertifizierungsinstitut GmbH Fachbereich F3  
 VDE Testing and Certification Institute Department F3

VDE

# VDE Prüf- und Zertifizierungsinstitut

## ZEICHENGENEHMIGUNG MARKS APPROVAL

Yung-Li Co. Ltd.  
Da Pu Industrial Zone, Cang Zi  
Chang Ping Town  
523571 DONG GUAN CITY  
Guangdong  
CHINA

ist berechtigt, für ihr Produkt /  
is authorized to use for their product

**Flexible Leitung**  
**Flexible cable (cord)**

die hier abgebildeten markenrechtlich geschützten Zeichen  
für die ab Blatt 2 aufgeführten Typen zu benutzen /  
the legally protected Marks as shown below for the types referred to on page 2 ff.



Geprüft und zertifiziert nach /  
Tested and certified according to

DIN VDE 0281-5 (VDE 0281 Teil 5):2002-09; HD 21.5 S3:1994 + A1:1999 + A2:2001

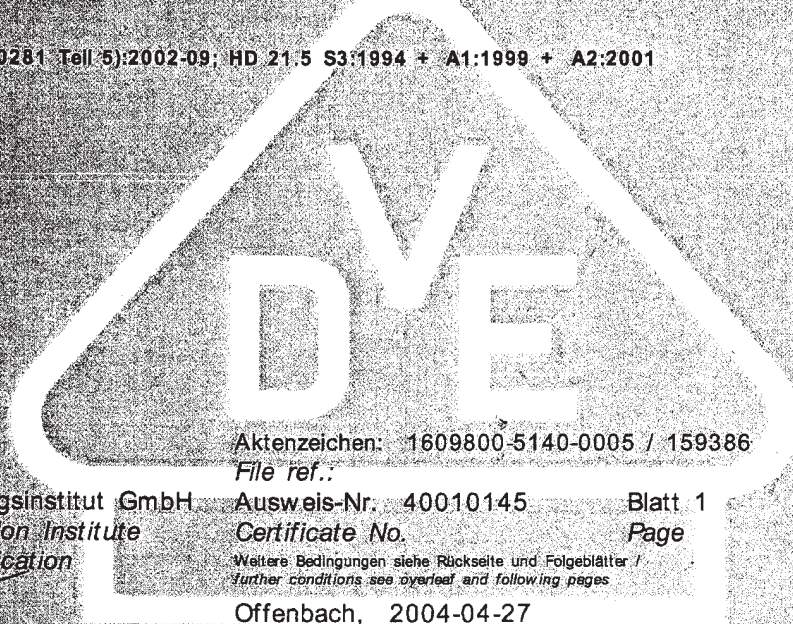

Aktenzeichen: 1609800-5140-0005 / 159386  
File ref..

VDE Prüf- und Zertifizierungsinstitut GmbH      Ausweis-Nr. 40010145      Blatt 1  
VDE Testing and Certification Institute      Certificate No.      Page  
Zertifizierungsstelle / Certification

Weitere Bedingungen siehe Rückseite und Folgeblätter /  
further conditions see overleaf and following pages

Offenbach, 2004-04-27  
(letzte Änderung/updated 2012-03-27 )

K. Prohaska

VDE Zertifikate sind nur gültig bei Veröffentlichung unter:  
VDE certificates are valid only when published on:

<http://www.vde.com/zertifikat>  
<http://www.vde.com/certificate>

# VDE



# VDE Prüf- und Zertifizierungsinstitut Zeichengenehmigung

Ausweis-Nr. / Blatt /  
Certificate No. page  
40010145 2

Name und Sitz des Genehmigungs-Inhabers / *Name and registered seat of the Certificate holder*  
Yung-Li Co. Ltd., Da Pu Industrial Zone, Cang Zi, Chang Ping Town, 523571 DONG GUAN CITY,  
Guangdong, CHINA

Aktenzeichen / *File ref.*  
1609800-5140-0005 / 159386 / FG42 / STR

letzte Änderung / *updated* Datum / *Date*  
2012-03-27 2004-04-27

Dieses Blatt gilt nur in Verbindung mit Blatt 1 des Zeichengenehmigungsausweises Nr. 40010145  
*This supplement is only valid in conjunction with page 1 of the Certificate No. 40010145.*

## Flexible Leitung *Flexible cable (cord)*

Typ(en) / *Type(s)*:

H03VV-F 2...4 x 0,5...0,75 mm <sup>2</sup>	+
H03VVH2-F 2 x 0,5...0,75 mm <sup>2</sup>	+
H05VV-F 2...5 x 0,75...4 mm <sup>2</sup>	+
H05VVH2-F 2 x 0,75...1,0 mm <sup>2</sup>	+

Firmenzeichen YUNG LI  
*Trademark*

Dieser Zeichengenehmigungs-Ausweis bildet eine Grundlage für die EG-Konformitätserklärung und CE-Kennzeichnung durch den Hersteller oder dessen Bevollmächtigten und bescheinigt die Konformität mit den grundlegenden Schutzanforderungen der **EG-Niederspannungsrichtlinie 2006/95/EG** mit ihren Änderungen.

*This Marks Approval is a basis for the EC Declaration of Conformity and the CE Marking by the manufacturer or his agent and proves the conformity with the essential safety requirements of the EC Low-Voltage Directive 2006/95/EC including amendments.*

VDE Prüf- und Zertifizierungsinstitut GmbH  
*VDE Testing and Certification Institute*  
Fachgebiet FG42  
*Section FG42*